

Characteristics 性能数据

Nominal capacity(1mA-2.0v-25°C).....	1200mAh
标称容量	
Nominal voltage.....	3.6v
额定电压	
Max.constant current.....	25mA
最大连续工作电流	
Max.pulse current.....	50mA
最大脉冲电流	
Weight.....	10g
电池重量	
Volume.....	Φ 14.5X25.5mm
电池尺寸	
Workable temperature.....	-60°C~+85°C
工作温度	

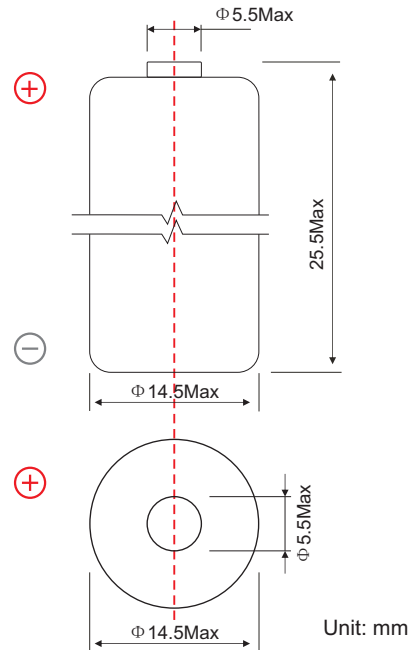

极端样式可按照客户要求定做

Discharge characteristic 放电特性 (25°C)

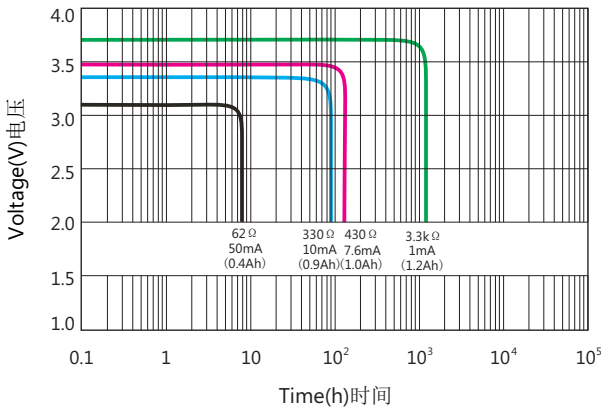

Voltage vs temperature 电压 vs 温度

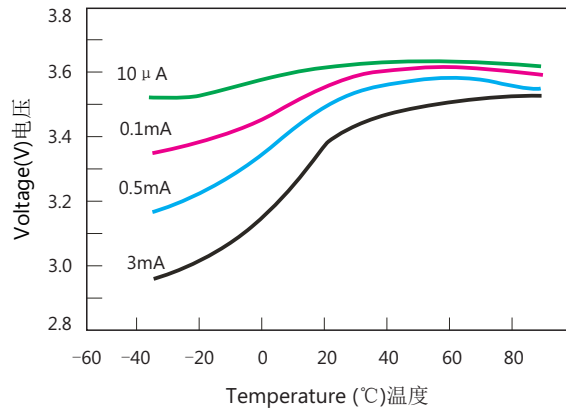

Capacity vs current 容量 vs 电流

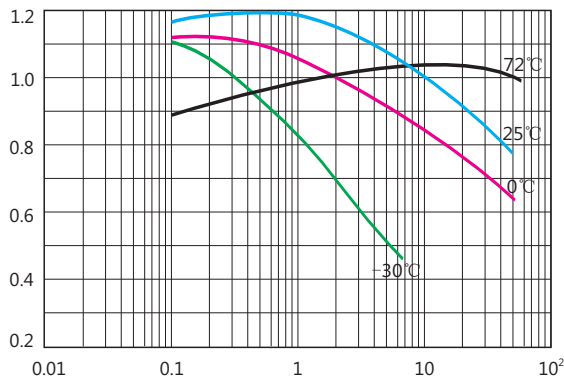

Storage characteristics 存储特性

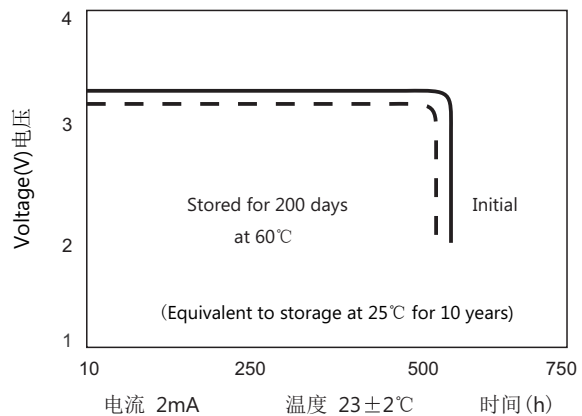

免责声明: 文中数据仅供参考, 不作电池性能的担保, 正式产品质量于购货合同中由供需双方确认

地址: 中国湖北武汉东西湖区吴家山台商投资区机电工业园

Add: Wujiashan Taiwan Businessmen Investment Zone, Wuhan, Hubei, China

P.C: 430040

Tel: 86-27-83258996

Fax: 86-27-83259120

E-mail: export@whforte.com

Http://www.whforte.com