

Characteristics 性能数据

Nominal capacity(0.5mA-2.0v).....	800mAh
标称容量	
Nominal voltage.....	3.6v
额定电压	
Max.constant current.....	200mA
最大连续工作电流	
Max.pulse current.....	300mA
最大脉冲电流	
Weight.....	11g
电池重量	
Volume.....	Φ 14.5X26.3mm
电池尺寸	
Workable temperature.....	-60℃~+85℃
工作温度	

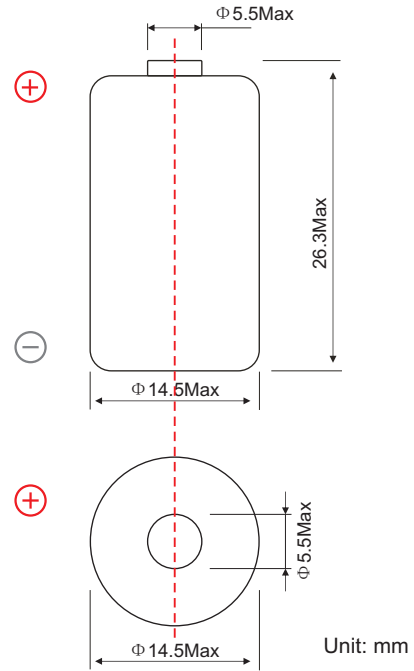

Discharge characteristic 放电特性 (25℃)

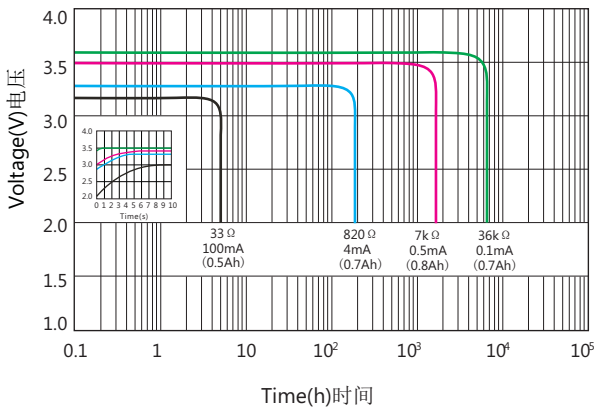

Voltage vs temperature 电压vs温度

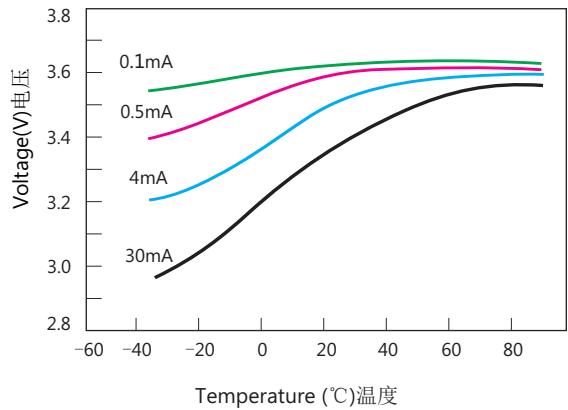

Capacity vs current 容量vs电流

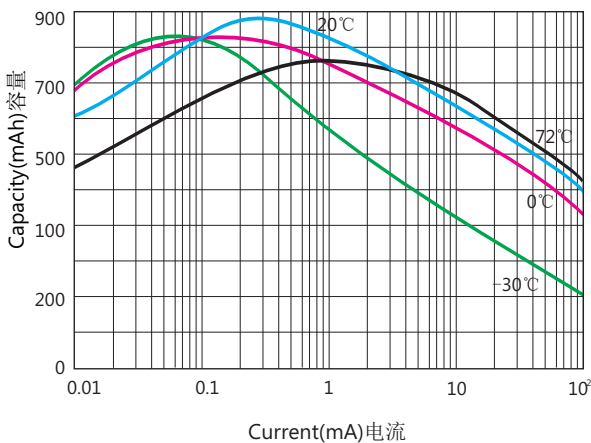

Storage characteristics 存储特性

