

Characteristics 性能数据

Nominal capacity(5mA-2.0v-25°C).....	850mAh
标称容量	
Nominal voltage.....	3.0v
额定电压	
Max.constant current.....	1000mA
最大连续工作电流	
Max.pulse current.....	2000mA
最大脉冲电流	
Weight.....	13g
电池重量	
Volume.....	Φ 15.5X27.5mm
电池尺寸	
Workable temperature.....	-40°C ~ +85°C
工作温度	

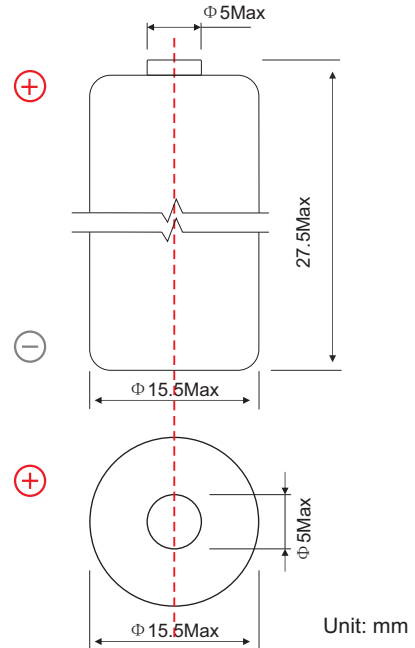

极端样式可按照客户要求定做

Discharge characteristic 放电特性 (25°C)

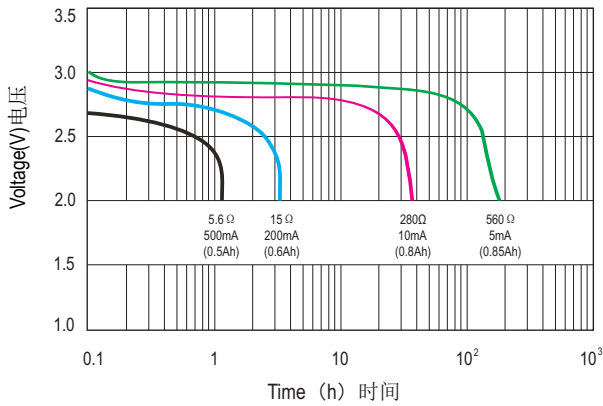

Temperature Characteristics 温度特性

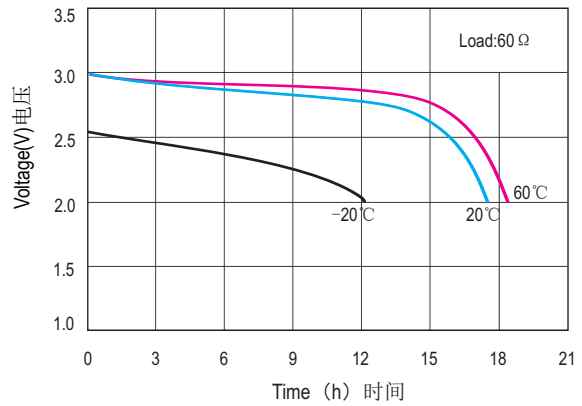

Load-Capacity Characteristics 脉冲放电特性

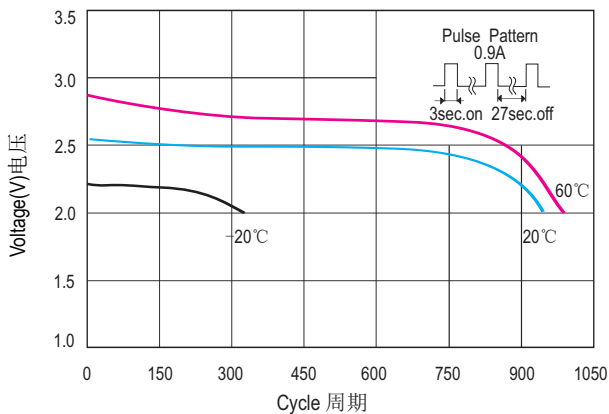

Storage characteristics 存储特性

