

Characteristics 性能数据

Nominal capacity(10mA-2.0v-25°C).....	2000mAh
标称容量	
Nominal voltage.....	3.0v
额定电压	
Max.constant current.....	1500mA
最大连续工作电流	
Max.pulse current.....	3000mA
最大脉冲电流	
Weight.....	26g
电池重量	
Volume.....	Φ 17.0X45.5mm
电池尺寸	
Workable temperature.....	-40°C ~ +85°C
工作温度	

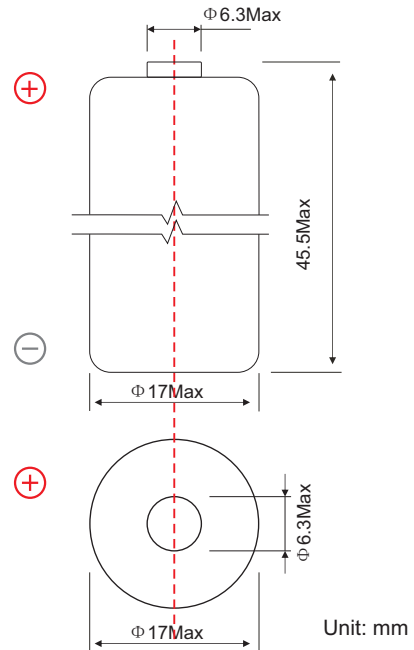

极端样式可按照客户要求定做

Discharge characteristic 放电特性 (25°C)

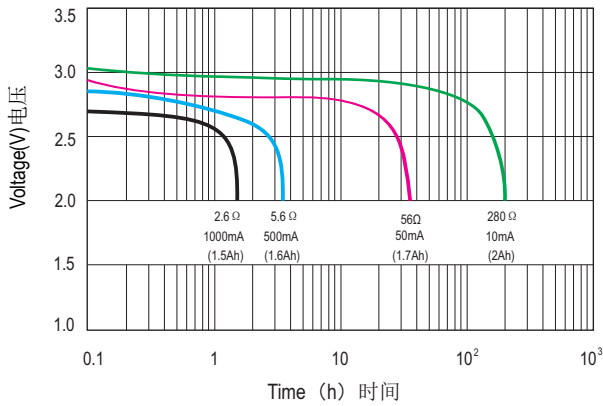

Temperature Characteristics 温度特性

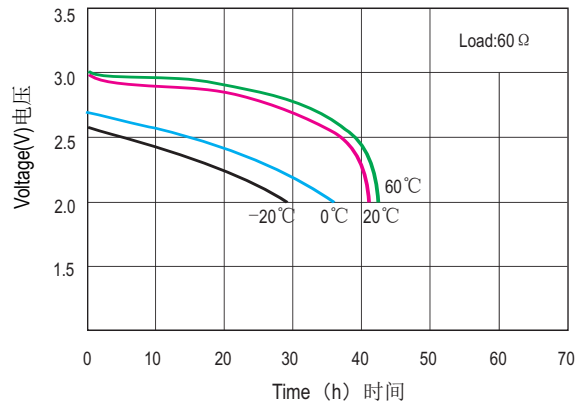

Capacity vs Resistance 容量vs电阻

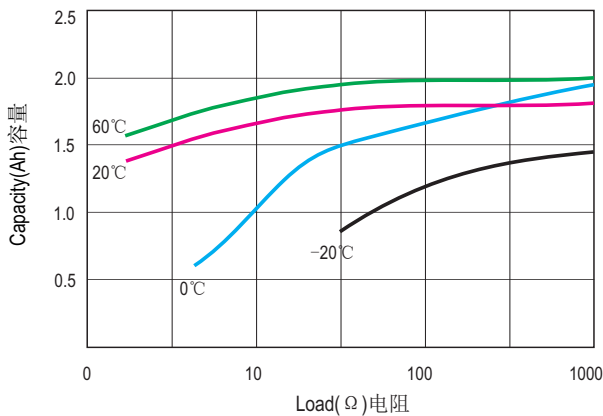

Storage characteristics 存储特性

